

FLOOR SINKS - STAINLESS STEEL

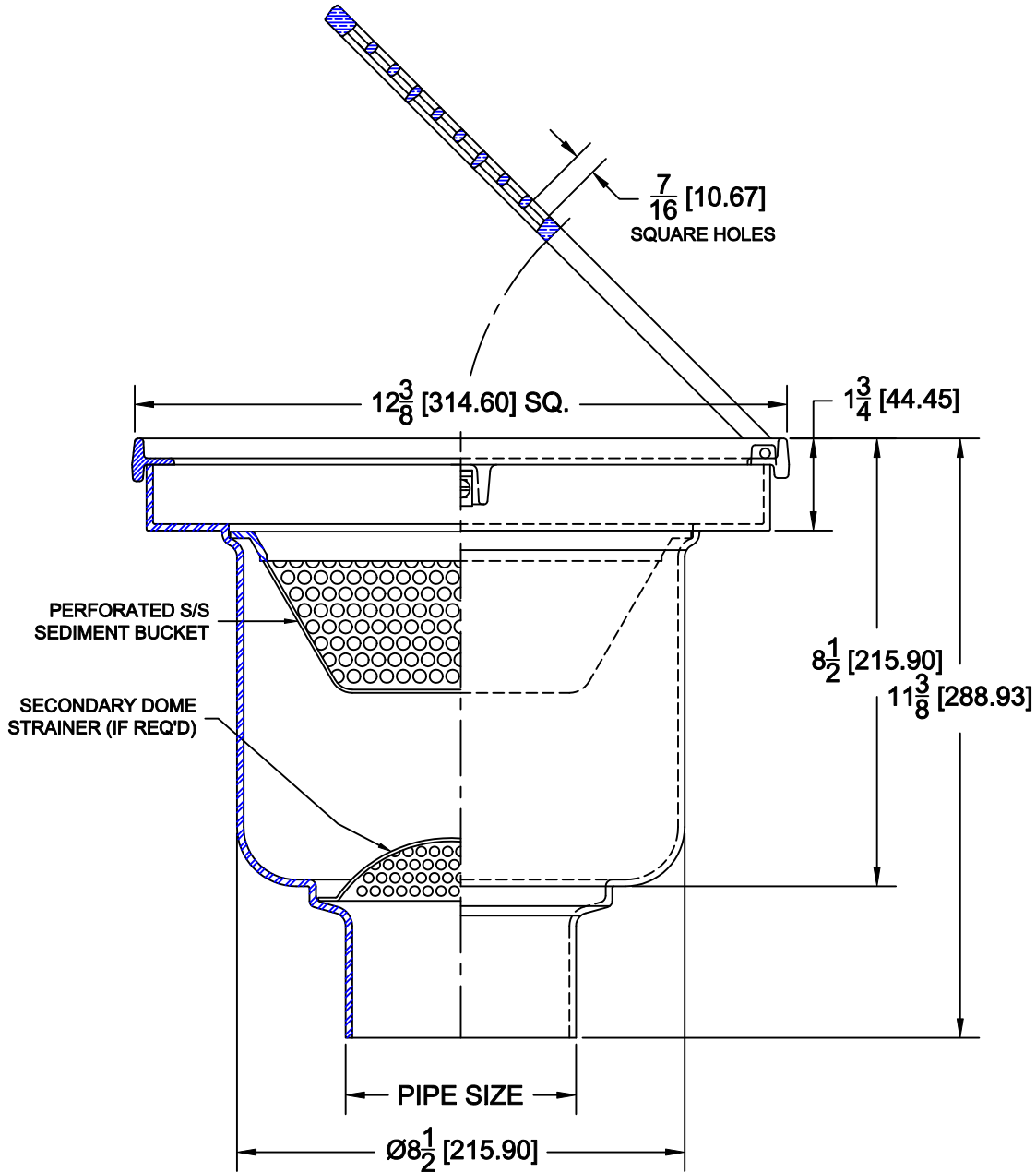

9740-1

STAINLESS STEEL 12" SQUARE FLOOR SINK WITH HINGED NICKEL BRONZE TOP, 8" DEEP ROUND SUMP PERFORATED SEDIMENT BASKET & BOTTOM OUTLET.



OPTIONS

Cat. No.	Pipe Size	Wt. Lbs.	Suffix	Description
<input type="checkbox"/> 9742-1	2 (50)	13.0	<input type="checkbox"/> 9	SECONDARY DOME STRAINER
<input type="checkbox"/> 9743-1	3 (75)	13.0	<input type="checkbox"/> 15	HALF GRATE
<input type="checkbox"/> 9744-1	4 (100)	13.0	<input type="checkbox"/> 16	THREE-QUARTER GRATE
<input type="checkbox"/> 9746-1	6 (100)	13.0	<input type="checkbox"/> 18	SOLID COVER
			<input type="checkbox"/> 19	GRATE W/ 2" DIA. HOLE IN CENTER
			<input type="checkbox"/> 26	FLANGE & CLAMP DEVICE

OUTLETS

Suffix	Description
<input type="checkbox"/> NH	NO-HUB
<input type="checkbox"/> TY	TY-SEAL

ANSI LOAD RATING - LD LIGHT DUTY (UNDER 2,000 LBS)

AutoCad.dwg